

# PRODUCT GUIDE



BEGINNING

MIDDLE

END



NO MATTER WHERE YOU ARE IN THE PROJECT  
**MAXCELL FITS**

**MaxCell**<sup>®</sup>  
FABRIC  
INNERDUCT

# NO MATTER WHERE YOU ARE IN THE PROJECT MAXCELL FITS

USED IN  
OVER



UTILITY, OIL & GAS

MILITARY

DATA CENTERS

TELECOM

GOVERNMENT

AIRPORTS

MUNICIPALITIES

BROADBAND & CABLE TV

EDUCATION & UNIVERSITIES

INDUSTRIES

STEP  
No.1

## FUNDING

From the outset, MaxCell will save you money by maximizing space available for network communication cables.

STEP  
No.2

## PLANNING, ENGINEERING & NETWORK DESIGN

Maximize your plant from the start! MaxCell can add up to three times as many pathways as traditional innerduct.

STEP  
No.3

## SPECIFICATIONS, ESTIMATING & PROJECT MANAGEMENT

Call your local MaxCell rep! They'll review specification requirements you need, calculate the MaxCell cost savings, and ensure MaxCell is delivered where you want, when you want.

STEP  
No.4

## PERMIT ACQUISITION

By using MaxSpace to reclaim space in your existing duct, you may be able to eliminate this step altogether. Ask us how.

STEP  
No.5

## PROCUREMENT

MaxCell is stocked nationally by multiple distributors — meaning your job stays on schedule.

STEP  
No.6

## CONSTRUCTION

Whether MaxCell or MaxSpace, our cost-saving solutions can deliver multiple pathways in a single conduit, simplifying even the most demanding projects.

STEP  
No.7

## SERVICING CUSTOMERS

MaxCell and MaxSpace expedite the delivery of services to customers, both new and existing.

## MAXCELL® IS THE ONLY FLEXIBLE FABRIC INNERDUCT SYSTEM DESIGNED SPECIFICALLY FOR THE NETWORK CONSTRUCTION INDUSTRY.

The unique fabric construction allows MaxCell to conform to the shape of cables placed within, greatly reducing the wasted space associated with rigid innerduct. Today's network operators use MaxCell to increase their cable density by as much as 300%. Faced with the challenge of deploying new infrastructure while minimizing investment costs, customers using MaxCell will:

- Reduce the number of conduits required for new network construction
- Minimize the need for additional conduit in occupied applications
- Enable incremental deployment to match system requirements

### WHY MAXCELL?

- Save on network construction
- Eliminate new network construction
- Reduce material and labor costs
- Install 2x faster
- Reduce freight and storage costs
- Provide cable sheath protection
- Place 300% more cables

### MAXCELL HAS BEEN SUCCESSFULLY INSTALLED IN A VARIETY OF APPLICATIONS INCLUDING:

- Broadband
- Wireless Backhaul
- Telecom
- Military
- Power/Utilities
- Data Centers
- Government
- Municipalities
- Education, Healthcare, Airport & Corporate Campuses

As the pioneer in fabric innerduct technology, MaxCell has the industry experience and know-how to develop unique solutions for specific application issues. Whether overbuild of an existing network or the deployment of cable, MaxCell can help you provide the right product and design to maximize the efficiency of your assets. Independent surveys and actual field experience prove that MaxCell reduces material and labor costs by 50% and more in most applications.

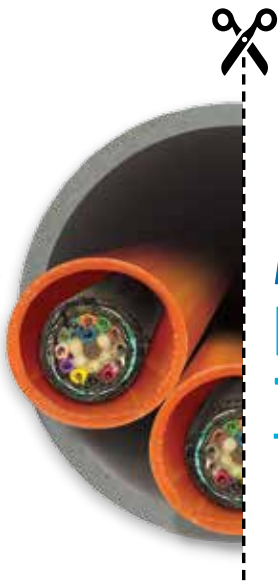

**ACTUAL FIELD EXPERIENCE REPORT // INSTALLERS AND NETWORK ENGINEERS CAN CUT CONDUIT INSTALLATION TIME IN HALF AND INCREASE CABLE INSTALLATION SPEED.**

# THE ULTIMATE SPACE SAVER

## COMPARE MAXCELL WITH RIGID INNERDUCT.

Network plant construction always seems to involve the same questions:

- How many conduits do we need for this new project?
- What is the cable capacity of each conduit?
- If there's already cable in the conduits, can we add more?
- How do we execute this project now and provide for future expansion?
- Can we accomplish this project now if we don't dig and install new conduits?

For years, the answers to these questions were driven by the limitations of rigid HDPE innerduct, resulting in wasted space, costly and difficult installations, excessive freight costs and limited options for future network expansions.

Since 1999, MaxCell has been the best answer. Our fabric innerduct is stronger and more flexible and offers more pathways than rigid innerduct. So it's easier to install. And it goes where rigid can't. Best of all, MaxCell makes it easy to expand in the future.

# 300%

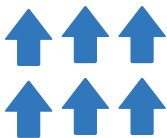

## CABLE DENSITY INCREASE



# FITS **3X**

## AS MUCH CABLE

**2-INCH CONDUIT** (WITH ONE RIGID INNERDUCT)



**2-INCH CONDUIT** (WITH MAXCELL INNERDUCT)



**4-INCH CONDUIT** (WITH THREE RIGID INNERDUCTS)



**4-INCH CONDUIT** (WITH MAXCELL INNERDUCT)



## THAT'S WHAT MAKES MAXCELL THE ULTIMATE SPACE SAVER!

## SINCE MAXCELL'S INTRODUCTION IN 1999, OVER 300 MILLION FEET OF PRODUCT HAVE BEEN DEPLOYED.

Whether servicing telecommunications companies or small municipalities, MaxCell offers an innovative solution to the global marketplace. With products designed to provide present and future value in network design, we continue to expand the market segments in which we participate. And it's not just product. Our customers understand that when using MaxCell, they get access to some of the best support in the industry. Our sales and technical staff not only make recommendations that are the most economical and beneficial for long-term design, but they also provide on-site training and field installation support.



### BROADBAND

Broadband service providers have used MaxCell for over ten years in virtually every known conduit application in their market, including large cable, urban, backbone cabling; through choke points of river bores, bridge and railroad crossings; to suburban fiber to the home applications. As the broadband service environment migrates from copper to fiber, MaxCell is strategically important for minimizing additional plant costs by reducing or eliminating the need for additional or new conduits in underground applications.



### TELECOM INDUSTRY

With industry leaders such as AT&T, NTT and Verizon among the global telecom giants using MaxCell, it's no wonder that it is one of the fastest-growing products in the network deployment industry. MaxCell applications include FTTH, Central Office backbone and Curb-to-Building deployments. And by "piggybacking" MaxCell in copper deployments, carriers can place the technology they need now while reducing the construction costs required for future fiber optic deployment.



### CELLULAR BACKHAUL

The wireless service providers continue to expand their program offerings, and every month new devices capable of receiving and sending more information and at much faster rates are rolled out to the consumer marketplace. However, wireless service providers struggle to provide bandwidth for the ever-growing offering and consumption. To answer these requirements, many wireless service providers are engaged with broadband operators to connect thousands of cellular tower antennas to land-based communication lines. Many of these cellular towers are connected to local power through conduit structures, and service providers are using MaxCell to override and place new connecting service lines in these same conduits.

# WHO USES MAXCELL



## EDUCATION, HEALTHCARE, AIRPORT & CORPORATE CAMPUSES

Communication among multiple buildings requires substantially expanded Local Area Network infrastructure. The increase of cable deployments requires system owners to make hard choices on the cost of installing new dense conduit structures, and they often seek solutions that will make use of existing structures. Whether MaxCell is deployed to condense multiple conduit backbone pathways or override existing plants, its ability to decrease or eliminate the need to dig new conduit structures saves network owners vast amounts of physical project funding, provides pathways for future needs and allows for projects to be completed in a much faster time frame.



## GOVERNMENT & MILITARY

Since 2000, MaxCell has been used in more than 200 military and government installations around the world. From the largest US bases in the United States, Europe and the Pacific to current deployments in the Middle East and remote outposts representing some of the harshest telecom environments in the world, MaxCell has been the preferred innerduct solution. With the knowledge that MaxCell is far less expensive to transport and install, and that it represents significant overall cost savings wherever the project may be, engineers and contracting officers continue to specify MaxCell for use in government telecom projects.



## DATA CENTERS

Data center construction is exploding in the communications network marketplace. Modern data centers are growing in size and complexity and often involve leased space to multiple companies in the same building. Vast amounts of different types of cable are required to operate data centers. MaxCell is currently being used to condense pathway structures from multiple redundant building entrance applications, and internal building cable management of power, HVAC, trunk and branch communication cables.

## LONG PULLS (AVOID SPLICING)

- PROBLEMS**
- Short pulls are not as cost effective as making single longer cable pulls
- MAXCELL SOLUTION**
- Pull MaxCell through multiple manholes
- GENERAL BENEFITS**
- Reduced overall set-up time as multiple setups are replaced by one
  - Eliminate some cable splices, saving thousands of dollars in labor
  - Faster cable placement
- 

## CELLULAR BACKHAUL

- PROBLEMS**
- Fiber or Ethernet based overrides in occupied ducts
  - Short underground connection to aerial plant
  - Longer connections to underground plant
- MAXCELL SOLUTION**
- Creates pathway(s) for insertion of new cables in already densely occupied smaller conduits
- GENERAL BENEFITS**
- Utilize existing duct structures
  - Avoid new trenching and conduit placement costs
  - Multiple product versions for smaller OD conduits
  - Future proof larger ducts for subsequent installations
- 

## OCCUPIED

- PROBLEMS**
- Existing outer ducts occupied with cables and/or HDPE rigid innerducts
  - Desire not to utilize last empty duct(s) (high congestion)
  - Microducts difficult to blow in occupied ducts with high fill ratio
  - Rigid innerducts may damage existing cables
- MAXCELL SOLUTION**
- Pull MaxCell over existing cables or innerducts (overlay) allowing additional cable(s) to be pulled in dedicated pathway
- GENERAL BENEFITS**
- Avoid new construction of additional outer duct/innerducts
  - Save remaining empty ducts in congested areas for future additions
  - Decrease time required to start up network
- 

## BRIDGES

- PROBLEMS**
- Limited conduit space
  - Limited space to maneuver equipment
  - Exposure to elements causes expansion and contraction of HDPE conduit and microducts
- MAXCELL SOLUTION**
- MaxCell in overlay or new construction
- GENERAL BENEFITS**
- MaxCell optimizes space within existing conduit structure
  - Lower coefficient of expansion eliminates expansion or contraction with temperature changes
  - Provides future pathways

## SPACE RECOVERY / RENEWAL

- PROBLEMS**
- Upgrade from copper to fiber can cause network downtime
  - Congested duct typically means copper must be removed prior to placing fiber
  - Single duct in outer duct is wasting space
- MAXCELL SOLUTION**
- Overbuild with MaxCell and place fiber prior to removing copper
  - Pull out copper or duct and pull in MaxCell
- GENERAL BENEFITS**
- Overbuilding allows service to remain intact until network switchover
  - Faster installation with MaxCell
- 

## CURB TO BUILDING

- PROBLEMS**
- Existing PVC or HDPE—short runs <500ft
  - Poor design with numerous sweeps and bends that make placing conduit or microduct difficult
  - Typically congested ducts
- MAXCELL SOLUTION**
- Place MaxCell in empty duct
  - Overlay MaxCell in existing congested duct
- GENERAL BENEFITS**
- Avoid construction
  - Quick deployment
  - No special equipment needed—typical hand pulls
  - Crew of two can do installation
- 

## PREMISE-RISER

- PROBLEMS**
- Congested riser space in buildings or MDUs makes drop cable placement difficult
  - Limited space for new EMT necessitating conduit fill
- MAXCELL SOLUTION**
- Add MaxCell in new construction for pathways
  - Overlay existing cables in riser with MaxCell
- GENERAL BENEFITS**
- Limited disruption in the building
  - Easier installation by hand
- 

## RIGHT-OF-WAY OBSTACLES

- PROBLEMS**
- Railroad crossings require significant permitting cost and time
  - Construction can inhibit traffic and create safety hazards for crew
- MAXCELL SOLUTION**
- Overlay MaxCell and cable in existing conduit
  - “Piggyback” MaxCell and cable to save space
- GENERAL BENEFITS**
- Saves permitting time and cost
  - Minimizes traffic disruption



## MAXCELL IS OFFERED IN MULTIPLE PRODUCT LINES & TYPES

Standard, Detectable, Plenum & Riser. MaxCell product types refer to the different conduit application sizes and number of cells/pathways per product type. Most product lines are offered in all of the product type variations.

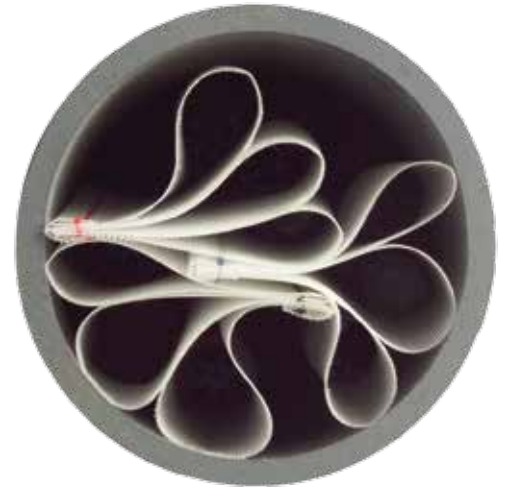

### STANDARD MAXCELL

A versatile solution for the complex problems faced by today's engineers, contractors and network providers. Manufactured from internally designed and produced materials, this model yields superior performance over existing rigid innerduct.

Standard MaxCell is the primary product line used in common outside plant applications, including long lines, under-bridge; road, river and rail borings; under streets and all the way to building entrance points. In dense multiple cables and multiple MaxCell pack installations where the conduit path is not clear to surface markers, Standard MaxCell is often partnered with Detectable MaxCell so that path or service interruption points can be easily located.

Standard MaxCell is available for conduit sizes ranging from 1" to 4", and in 1-, 2- and 3-cell configurations — giving you the flexibility to choose the right product for your system and applications.

### FEATURES & ADVANTAGES:

- Melt point of 419°F — almost 2X of HDPE
- Resistant to ground chemicals and petroleum products
- Pre-lubed for lower friction during MaxCell and cable installation
- Pull tape included



**419** °FAHRENHEIT  
MELTING  
POINT   
ALMOST **2X** MORE COMPARED TO HDPE

# EMBEDDED 18 GAUGE SOLID COPPER WIRE

## DETECTABLE MAXCELL

Created to answer applications requiring locatable paths, Detectable Maxcell has an embedded 18 gauge solid copper wire suitable for direct wired toning equipment as well as above-ground handheld locators. Other historic detection products required additional installation or an additional pull tape, which was often used and therefore lost during subsequent expansion installations. All products are available in detectable versions.

### FEATURES & ADVANTAGES:

- **Reliable method for locating cables deployed in buried conduit**
- **Detectable with any industry-standard toning equipment**
- **The wire is inserted into the edge of MaxCell, not in the cable pathways, and provides the following advantages over separate/free-floating wires of detectable pull tapes:**
  - **PERMANENT:** Will not be removed once installed, as is the case with a detectable pull tape
  - **PROTECTED:** Avoids damage to the wire during cable installation as commonly occurs over separate/free-floating wires or detectable pull tapes
  - **EASY INSTALLATION**
- **As an embedded feature, Detectable MaxCell:**
  - Requires no additional pull tapes for installation
  - Will not entangle or impede cable installations, nor increase pulling tensions or friction on cables during installation

*No special installation techniques are required beyond standard MaxCell procedures, and the wire does not adversely affect pulling tensions or the flexible nature of MaxCell. Please note that the 18 gauge solid copper wire should not be used for grounding purposes.*



## WIRE DATA

<b>AWG</b>	18G TFN Solid Copper Core
<b>NOMINAL OD</b>	78 mils
<b>COLOR</b>	Green
<b>MAX VOLTAGE</b>	600C
<b>INSULATION</b>	15 mils Vinyl
<b>AMPACITY</b>	6



## PLENUM MAXCELL

Plenum MaxCell provides numerous pathways for installation of multiple plenum cables in building environments. Plenum MaxCell is for installation in ducts, plenums, risers or other environmental air spaces and is compliant with UL Standard 2024—“Outline of Investigation for Optical Fiber Cable Routing Systems (Plenum).”

### FEATURES & ADVANTAGES:

- Maximize cable density for plenum applications
- Easy installation of cables — short runs often done easily by hand
- Simplifies removal of obsolete cables
- Plenum MaxCell is available in 1”, 2”, 3” and 4” conduit versions

PRODUCT	PART NUMBER	FOOTAGE (FEET)
3" 3-Cell Plenum, Standard Color Black	MXP3456BK1000	1,000'
	MXP3456BK5300	5,300'
2" 2-Cell Plenum, Standard Color Black	MXP2002PRBK1000	1,000'
	MXP2002PRBK5300	5,300'
2" 3-Cell Plenum, Standard Color Yellow	MXP2003YL1000	1,000'
	MXP2003YL5300	5,300'
2" 1-Cell Plenum, Standard Color White	MXP2001WH1000	1,000'
	MXP2001WH5300*	5,300'
1-Cell Plenum, Standard Color Black	MXPM3301BK1000*	1,000'
	MXPM3301BK5300	5,300'

\*1" MaxCell Version.

## RISER MAXCELL

Riser MaxCell is for effective cable and fiber optic management within interior raceways and for installation in vertical runs or shafts.

### FEATURES & ADVANTAGES:

- Provides dedicated pathways in congested riser ducts
- Allows for future expansion
- Easy switch-out of cables when required
- Riser MaxCell is available in 1”, 2”, 3” and 4” conduit versions

PRODUCT	PART NUMBER	FOOTAGE (FEET)
3" 3-Cell Riser, Standard Color Black	MXR3456BK1000	1,000'
	MXR3456BK5300	5,300'
2" 2-Cell Riser, Standard Color Black	MXR2002PRBK1000	1,000'
	MXR2002PRBK5300	5,300'
2" 3-Cell Riser, Standard Color Yellow	MXR2003YL1000	1,000'
	MXR2003YL5300	5,300'
4" 3-Cell Riser, Standard Color Green	MXR4003GR1000	1,000'
	MXR4003GR5300	5,300'
2" 1-Cell Riser, Standard Color White	MXR2001WH1000	1,000'
	MXR2001WH5300	5,300'
1-Cell Riser, Standard Color Black	MXRM3301BK1000*	1,000'
	MXRM3301BK5300	5,300'

\*1" MaxCell Version.



# 4 INCH — 3-CELL



4" 3-Cell packs with 6 1" OD cables in 4" conduit



4" 3-Cell packs overriding existing cable plant

## 4" 3-CELL

For use in 4" or larger conduits, the 4" 3-Cell product is designed to hold larger backbone cables up to 1.5" in diameter in each cell. Up to two packs can be placed in a 4" conduit.

- Standard color is green
- Color-coded pull tapes are preinstalled
- Factory lubricated

## 4" 3-CELL APPLICATION GUIDE | General Guidelines When Using MaxCell in Various Applications

**MaxCell 4" 3-Cell (Equivalent to three 1.5" I.D. innerducts)** This product was designed for use in 4" or larger ducts. Multiple combinations of large and medium cable sizes are applicable. Since larger cable applications are anticipated, the number of cables and packs that can be placed is reduced; therefore, a smaller number of cables is available.

MIN CONDUIT ID	SUGGESTED PRODUCT	MAX # OF PACKS	MAX # OF CABLES	MAXIMUM CABLE DIAMETER PER CELL	REC. PULL LENGTH*	MAX PULL LENGTH*
4"	MaxCell 4" 3-Cell	2	6	1.5"	1,250'	2,000'
5"	MaxCell 4" 3-Cell	3	9	1.5"	1,250'	2,000'
6"	MaxCell 4" 3-Cell	4	12	1.5"	1,250'	2,000'

\*Use of OFNR cable may result in reduced pulling lengths. Designers should make every effort to conform to industry standards with regard to distances between any two pull points (generally 600 to 1,000 feet), number of bends (maximum of two 90 degree bends or a total of 180 degrees) between any two pull points, and proofing of conduit pathway using appropriately sized mandrels (normally 1/4 to 1/2 inch less than the inside diameter of the conduit).

## 4" 3-CELL PART NUMBERS

PRODUCT (STD. COLOR)	FOOTAGE (FEET)	STANDARD PRODUCT (MXC)	DETECTABLE PRODUCT (MXD)	PLENUM PRODUCT (MXP)	RISER PRODUCT (MXR)
4" 3-Cell Product Standard color is Green (GR)	250	MXC4003XX250	MXD4003XX250	MXP4003XX250	MXR4003XX250
	500-999	MXC4003XX500	MXD4003XX500	MXP4003XX500	MXR4003XX500
	1,000-2,649	MXC4003XX1000	MXD4003XX1000	MXP4003XX1000	MXR4003XX1000
	2,650-5,299	MXC4003XX2650	MXD4003XX2650	MXP4003XX2650	MXR4003XX2650
	5,300-9,999	MXC4003XX5300	MXD4003XX5300	MXP4003XX5300	MXR4003XX5300
	10,000	MXC4003XX10000	MXD4003XX10000	MXP4003XX10000	MXR4003XX10000

## 4" 3-CELL REEL SIZES AND WEIGHTS

DESCRIPTION	STD. PRODUCT LENGTH	REEL SIZE	TYPE OF REEL	TARE WEIGHT OF REEL	REEL WT. W/ STD. PRODUCT LENGTH	MAX PRODUCT ON REEL
4" 3-Cell Standard/Riser/Plenum MXC4003 Product Wt: 107.5 lbs/1,000ft	500'	33"H x 15"W	Composite	60 lbs	114 lbs	1,133'
	1,000'	33"H x 15"W	Composite	60 lbs	168 lbs	1,133'
	2,650'	48"H x 22"W	Steel	78 lbs	340 lbs	4,267'
	5,300'	72"H x 22"W	Steel	88 lbs	658 lbs	8,099'
	10,000'	72"H x 30"W	Steel	106 lbs	1,181 lbs	10,000'

Add 8.5 lbs per 1,000ft for Detectable product weight estimates.

# 3 INCH — 3-CELL

## 3" 3-CELL

For use in 3" or larger conduits, the 3" 3-Cell product is designed to hold cables up to 1.05" in diameter in each cell. Up to 3 packs can be placed in a 4" conduit.

- Standard colors are black, blue or red
- Color-coded pull tapes are preinstalled
- Factory lubricated



3" 3-Cell pack overriding existing cable plant in 4" conduit



3" 3-Cell packs, 9 cables in 4" conduit

## 3" 3-CELL APPLICATION GUIDE

### General Guidelines When Using MaxCell in Various Applications

**MaxCell 3" 3-Cell (Equivalent to three 1.25" I.D. innerducts)** This product was designed for use in 3" or larger ducts. Multiple combinations of large, medium and smaller cable sizes are applicable and anticipated.

MIN CONDUIT ID	SUGGESTED PRODUCT	MAX # OF PACKS	MAX # OF CABLES	MAXIMUM CABLE DIAMETER PER CELL	REC. PULL LENGTH*	MAX PULL LENGTH*
3"	MaxCell 3" 3-Cell	2	6	1.05"	1,250'	2,000'
4"	MaxCell 3" 3-Cell	3	9	1.05"	1,250'	2,000'
5"	MaxCell 3" 3-Cell	4	12	1.05"	1,250'	2,000'
6"	MaxCell 3" 3-Cell	5	15	1.05"	1,250'	2,000'

\*Use of OFNR cable may result in reduced pulling lengths. Designers should make every effort to conform to industry standards with regard to distances between any two pull points (generally 600 to 1,000 feet), number of bends (maximum of two 90 degree bends or a total of 180 degrees) between any two pull points, and proofing of conduit pathway using appropriately sized mandrels (normally 1/4 to 1/2 inch less than the inside diameter of the conduit).

## 3" 3-CELL PART NUMBERS

PRODUCT (STD. COLOR)	FOOTAGE (FEET)	STANDARD PRODUCT (MXC)	DETECTABLE PRODUCT (MXD)	PLENUM PRODUCT (MXP)	RISER PRODUCT (MXR)
3" 3-Cell Product Standard colors are either Black (BK) or Blue (BL) or Red (RD)	250	MXC3456XX250	MXD3456XX250	MXP3456XX250	MXR3456XX250
	500-999	MXC3456XX500	MXD3456XX500	MXP3456XX500	MXR3456XX500
	1,000-2,649	MXC3456XX1000	MXD3456XX1000	MXP3456XX1000	MXR3456XX1000
	2,650-5,299	MXC3456XX2650	MXD3456XX2650	MXP3456XX2650	MXR3456XX2650
	5,300-9,999	MXC3456XX5300	MXD3456XX5300	MXP3456XX5300	MXR3456XX5300
	10,000	MXC3456XX10000	MXD3456XX10000	MXP3456XX10000	MXR3456XX10000

## 3" 3-CELL REEL SIZES AND WEIGHTS

DESCRIPTION	STD. PRODUCT LENGTH	REEL SIZE	TYPE OF REEL	TARE WEIGHT OF REEL	REEL WT. W/ STD. PRODUCT LENGTH	MAX PRODUCT ON REEL
3" 3-Cell Standard/Riser/Plenum MXC3456 Product Wt: 88.5 lbs/1,000ft	500'	33"H x 15"W	Composite	60 lbs	104 lbs	1,407'
	1,000'	33"H x 15"W	Composite	60 lbs	149 lbs	1,407'
	2,650'	33"H x 22"W	Composite	85 lbs	320 lbs	2,667'
	5,300'	48"H x 22"W	Steel	78 lbs	525 lbs	5,300'
	10,000'	72"H x 30"W	Steel	106 lbs	991 lbs	10,000'

Add 8.5 lbs per 1,000ft for Detectable product weight estimates.

**3" 4-CELL STANDARD** MXC3004 | Product Wt: 96 lbs/1,000ft

Call for information

# 2 INCH — 3-CELL



2" 3-Cell packs,  
6 cables in 3" conduit



2" 3-Cell pack in 2" conduit

## 2" 3-CELL

For use in 2" conduits, the 2" 3-Cell product is designed to hold three cables up to 0.85" in diameter in each cell.

- Standard color is yellow
- Color-coded pull tapes are preinstalled
- Factory lubricated

## 2" 3-CELL APPLICATION GUIDE | General Guidelines When Using MaxCell in Various Applications

**MaxCell 2" 3-Cell (Equivalent to three 1.0" I.D. innerducts)** This product was designed for use in 2" ducts where three cables are being placed.

MIN CONDUIT ID	SUGGESTED PRODUCT	MAX # OF PACKS	MAX # OF CABLES	MAXIMUM CABLE DIAMETER PER CELL	REC. PULL LENGTH*	MAX PULL LENGTH*
2"	MaxCell 2" 3-Cell	1	3	.85"	800'	1,500'

\*Use of OFNR cable may result in reduced pulling lengths. Designers should make every effort to conform to industry standards with regard to distances between any two pull points (generally 600 to 1,000 feet), number of bends (maximum of two 90 degree bends or a total of 180 degrees) between any two pull points, and proofing of conduit pathway using appropriately sized mandrels (normally ¼ to ½ inch less than the inside diameter of the conduit).

## 2" 3-CELL PART NUMBERS

PRODUCT (STD. COLOR)	FOOTAGE (FEET)	STANDARD PRODUCT (MXC)	DETECTABLE PRODUCT (MXD)	PLENUM PRODUCT (MXP)	RISER PRODUCT (MXR)
2" 3-Cell Product Standard color is Yellow (YL)	250	MXC2003XX250	MXD2003XX250	MXP2003XX250	MXR2003XX250
	500-999	MXC2003XX500	MXD2003XX500	MXP2003XX500	MXR2003XX500
	1,000-2,649	MXC2003XX1000	MXD2003XX1000	MXP2003XX1000	MXR2003XX1000
	2,650-5,299	MXC2003XX2650	MXD2003XX2650	MXP2003XX2650	MXR2003XX2650
	5,300-9,999	MXC2003XX5300	MXD2003XX5300	MXP2003XX5300	MXR2003XX5300
	10,000	MXC2003XX10000	MXD2003XX10000	MXP2003XX10000	MXR2003XX10000

## 2" 3-CELL REEL SIZES AND WEIGHTS

DESCRIPTION	STD. PRODUCT LENGTH	REEL SIZE	TYPE OF REEL	TARE WEIGHT OF REEL	REEL WT. W/ STD. PRODUCT LENGTH	MAX PRODUCT ON REEL
2" 3-Cell Standard/Riser/Plenum MXC2003 Prod. Wt: 76 lbs/1,000ft	500'	33"H x 15"W	Composite	60 lbs	98 lbs	1,592'
	1,000'	33"H x 15"W	Composite	60 lbs	136 lbs	1,592'
	2,650'	33"H x 22"W	Composite	85 lbs	287 lbs	3,018'
	5,300'	48"H x 22"W	Steel	78 lbs	458 lbs	5,997'
	10,000'	72"H x 22"W	Steel	88 lbs	848 lbs	10,000'

Add 8.5 lbs per 1000ft for Detectable product weight estimates

# 2 INCH — 2-CELL

## 2" 2-CELL

For use in 2" conduits, the 2" 2-Cell product is designed to hold two cables up to 0.85" in diameter in each cell. It's ideal for overlay when one cable exists in a 2" conduit.

- Standard color is black
- Color-coded pull tapes are pre-installed
- Factory lubricated



2" 2-Cell pack in 2" conduit

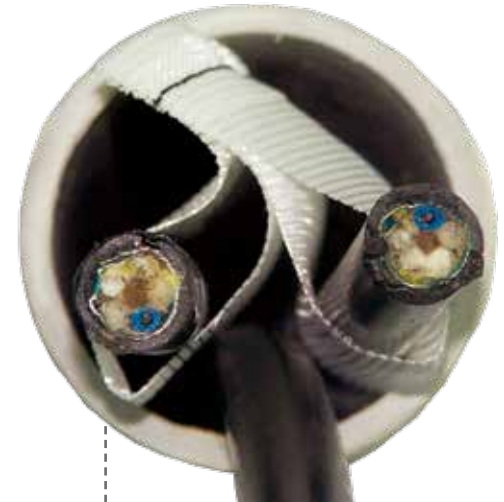

2" 2-Cell pack overriding incumbent cable in 2" conduit

## 2" 2-CELL APPLICATION GUIDE

### General Guidelines When Using MaxCell in Various Applications

**MaxCell 2" 2-Cell (Equivalent to two 1.0" I.D. innerducts)** This product was designed for use in 2" ducts where two cables are being placed.

MIN CONDUIT ID	SUGGESTED PRODUCT	MAX # OF PACKS	MAX # OF CABLES	MAXIMUM CABLE DIAMETER PER CELL	REC. PULL LENGTH*	MAX PULL LENGTH*
2"	MaxCell 2" 3-Cell	1	2	.85"	800'	1,500'

\*Use of OFNR cable may result in reduced pulling lengths. Designers should make every effort to conform to industry standards with regard to distances between any two pull points (generally 600 to 1,000 feet), number of bends (maximum of two 90 degree bends or a total of 180 degrees) between any two pull points, and proofing of conduit pathway using appropriately sized mandrels (normally 1/4 to 1/2 inch less than the inside diameter of the conduit).

## 2" 2-CELL PART NUMBERS

PRODUCT (STD. COLOR)	FOOTAGE (FEET)	STANDARD PRODUCT (MXC)	DETECTABLE PRODUCT (MXD)	PLENUM PRODUCT (MXP)	RISER PRODUCT (MXR)
2" 2-Cell Product Standard color is Black (BK)	250	MXC2002XX250	MXD2002XX250	MXP2002XX250	MXR2002XX250
	500-999	MXC2002XX500	MXD2002XX500	MXP2002XX500	MXR2002XX500
	1,000-2,649	MXC2002XX1000	MXD2002XX1000	MXP2002XX1000	MXR2002XX1000
	2,650-5,299	MXC2002XX2650	MXD2002XX2650	MXP2002XX2650	MXR2002XX2650
	5,300-9,999	MXC2002XX5300	MXD2002XX5300	MXP2002XX5300	MXR2002XX5300
	10,000	MXC2002XX10000	MXD2002XX10000	MXP2002XX10000	MXR2002XX10000

## 2" 2-CELL REEL SIZES AND WEIGHTS

DESCRIPTION	STD. PRODUCT LENGTH	REEL SIZE	TYPE OF REEL	TARE WEIGHT OF REEL	REEL WT. W/ STD. PRODUCT LENGTH	MAX PRODUCT ON REEL
2" 2-Cell Standard/Riser/Plenum MXC2002 Prod. Wt: 51.5 lbs/1,000ft	500'	33"H x 15"W	Composite	60 lbs	86 lbs	2,336'
	1,000'	33"H x 15"W	Composite	60 lbs	112 lbs	2,336'
	2,650'	33"H x 22"W	Composite	85 lbs	222 lbs	4,429'
	5,300'	48"H x 22"W	Steel	78 lbs	328 lbs	8,802'
	10,000'	72"H x 22"W	Steel	88 lbs	603 lbs	10,000'

Add 8.5 lbs per 1,000ft for Detectable product weight estimates.

# 2 INCH — 1-CELL



2" 1-Cell MaxCell overriding incumbent cable in 2" conduit

## 2" 1-CELL

For use in 1.5" and 2" conduits, the 2" 1-Cell product is designed to hold cables up to 0.85" in diameter in each cell.

- Standard color is white
- Color-coded pull tapes are preinstalled
- Factory lubricated

## 2" 1-CELL APPLICATION GUIDE | General Guidelines When Using MaxCell in Various Applications

**MaxCell 2" 1-Cell (Equivalent to one 1.0" I.D. innerducts)** This product was designed for use in 1.5" and 2" ducts. It is designed to deploy an additional cable in a confined small conduit or innerduct.

MIN CONDUIT ID	SUGGESTED PRODUCT	MAX # OF PACKS	MAX # OF CABLES	MAXIMUM CABLE DIAMETER PER CELL	REC. PULL LENGTH*	MAX PULL LENGTH*
1.5" +	MaxCell 2" 1-Cell	1	1	.85"	800'	1,500'

\*Use of OFNR cable may result in reduced pulling lengths. Designers should make every effort to conform to industry standards with regard to distances between any two pull points (generally 600 to 1,000 feet), number of bends (maximum of two 90 degree bends or a total of 180 degrees) between any two pull points, and proofing of conduit pathway using appropriately sized mandrels (normally 1/4 to 1/2 inch less than the inside diameter of the conduit).

## 2" 1-CELL PART NUMBERS

PRODUCT (STD. COLOR)	FOOTAGE (FEET)	STANDARD PRODUCT (MXC)	DETECTABLE PRODUCT (MXD)	PLENUM PRODUCT (MXP)	RISER PRODUCT (MXR)
2" 1-Cell Product Standard color is White (WH)	250	MXC2001XX250	MXD2001XX250	MXP2001XX250	MXR2001XX250
	500-999	MXC2001XX500	MXD2001XX500	MXP2001XX500	MXR2001XX500
	1,000-2,649	MXC2001XX1000	MXD2001XX1000	MXP2001XX1000	MXR2001XX1000
	2,650-5,299	MXC2001XX2650	MXD2001XX2650	MXP2001XX2650	MXR2001XX2650
	5,300-9,999	MXC2001XX5300	MXD2001XX5300	MXP2001XX5300	MXR2001XX5300
	10,000	MXC2001XX10000	MXD2001XX10000	MXP2001XX10000	MXR2001XX10000

## 2" 1-CELL REEL SIZES AND WEIGHTS

DESCRIPTION	STD. PRODUCT LENGTH	REEL SIZE	TYPE OF REEL	TARE WEIGHT OF REEL	REEL WT. W/ STD. PRODUCT LENGTH	MAX PRODUCT ON REEL
2" 1-Cell Standard/Riser/Plenum MXC2001 Prod. Wt: 28 lbs/1,000ft	500'	33"H x 15"W	Composite	60 lbs	74 lbs	4,390'
	1,000'	33"H x 15"W	Composite	60 lbs	88 lbs	4,390'
	2,650'	33"H x 15"W	Composite	60 lbs	135 lbs	4,390'
	5,300'	33"H x 22"W	Composite	85 lbs	234 lbs	8,322'
	10,000'	48"H x 22"W	Steel	78 lbs	335 lbs	10,000'

Add 8.5 lbs per 1,000ft for Detectable product weight estimates.



## SELF-SUPPORTING MAXCELL

A flexible fabric pathway system designed specifically for transporting cables efficiently in data centers, drop ceilings, and areas that require adaptable reconfigurations. The integrated support structure and multiple pathways reduce the steps required to place cables, minimizing time for installation.

### KEY FEATURES

- Plenum-rated MaxCell
- Configured with 3 cells to support network flexibility and growth
- Preinstalled galvanized support wire – strong and flexible
- Preinstalled color-coded pulling tapes to speed cable installation
- Works with support systems from an extensive group of manufacturers

### BENEFITS

- Installs the same as a standard wire
- Install bundles of 24 CAT 6 cables without Velcro™ or cable ties
- Up to 72+ cables in one MaxCell pack
- Reduce cable install by up to 30% compared to cable tray
- Reduce cable damage and installation re-work



## SELF-SUPPORTING PART NUMBER

PART NUMBER	# PATHWAYS	PRODUCT WIDTH	MAXIMUM AGGREGATE CABLE DIAMETER	STATIC LOAD F
MXP43SSXX	3	3.3"	1.8"	20 lbs

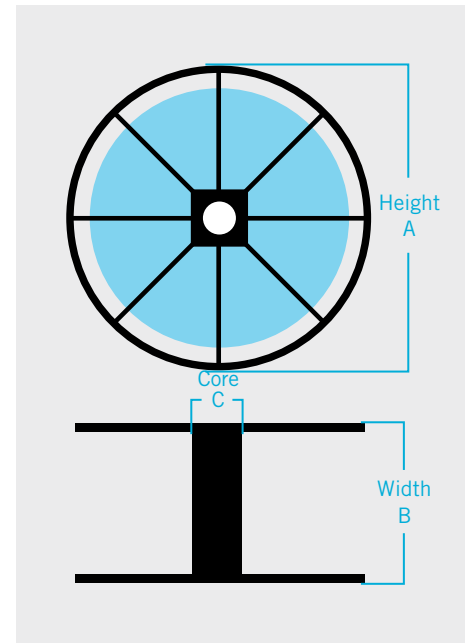

## SELF-SUPPORTING MAXCELL PACKAGING

PACKAGE TYPE	MATERIAL OF CONSTRUCTION		EMPTY REEL WT.	MAXIMUM REEL CAPACITY	EXACT DIMENSIONS		
	Flange	Core			Height A	Width B	Core C
Plastic Reel	Plastic	Plastic	4 lbs	500'	22"	19"	6"
33" x 15" Wood Reel	3/4" Plywood	Fiberboard	24 lbs	1,000'	33"	15"	8"
33" x 22" Wood Reel	3/4" Plywood	Fiberboard	26 lbs	1,500'	33"	22"	8"

All dimensions are approximate, are intended to be used for reference purposes and are subject to change. Prior to shipping, all reels are wrapped with a UV protective film. Designers should make every effort to conform to industry standards with regard to distances between any two pull points (generally 600 to 1,000 feet), number of bends (maximum of two 90 degree bends or a total of 180 degrees) between any two pull points, and proofing of conduit pathway using appropriately sized mandrels (normally 1/4 to 1/2 inch less than the inside diameter of the conduit).

# 1 INCH MAXCELL

## FOR USE IN 1.25" TO 2" ID CONDUITS. 3-CELL, 2-CELL AND SINGLE CELL CONFIGURATIONS.

1" MaxCell products can be used to create additional pathways in small conduits.

- Designed for use underground as well as aerial duct applications
- Ideal for use in MDU applications where frequent entry in conduit is required
- Enables overlay of cables in occupied conduits
- Reduces or eliminates number of conduits required in new construction
- No special blowing equipment is required
- Features low friction MaxGlide rope in each cell
- Pre-lubed for easier installation



1" MaxCell overriding existing cable plant in a 3" duct

## 1" MAXCELL APPLICATION GUIDE | General Guidelines When Using MaxCell in Various Applications

MIN CONDUIT ID	SUGGESTED PRODUCT	MAX # OF PACKS	MAX # OF CABLES	MAXIMUM CABLE DIAMETER PER CELL	REC. PULL LENGTH <sup>‡</sup>	MAX PULL LENGTH <sup>‡</sup>
1.25	MX^M330* 3-Cell	1	3	.472"	800'	1,500'
1.25	MX^M330* 2-Cell	1	2	.472"	800'	1,500'
1.25	MX^M330* 1-Cell	1	1	.472"	800'	1,500'

1" MaxCell is designed for use in smaller applications where space is limited.

- Λ = C for Standard MaxCell      \* = 1-, 2- or 3-Cell MaxCell
- D for Detectable MaxCell
- P for Plenum MaxCell
- R for Riser MaxCell

<sup>‡</sup> Use of OFNR cable may result in reduced pulling lengths. Designers should make every effort to conform to industry standards with regard to distances between any two pull points (generally 600 to 1,000 feet), number of bends (maximum of two 90 degree bends or a total of 180 degrees) between any two pull points, and proofing of conduit pathway using appropriately sized mandrels (normally ¼ to ½ inch less than the inside diameter of the conduit). This information is provided as general guidelines for MaxCell use and are for reference only. Construction practices and variations may result in reduced pulling lengths. Contact MaxCell Support to review your project.



# PART NUMBERS

PRODUCT (STD. COLOR)	FOOTAGE (FEET)	STANDARD PRODUCT (MXC)	DETECTABLE PRODUCT (MXD)	PLENUM PRODUCT (MXP)	RISER PRODUCT (MXR)
1" 3-Cell Product Standard color is Black (BK)	250	MXCM3303XX250	MXDM3303XX250	MXPM3303XX250	MXRM3303XX250
	500-999	MXCM3303XX500	MXDM3303XX500	MXPM3303XX500	MXRM3303XX500
	1,000-2,649	MXCM3303XX1000	MXDM3303XX1000	MXPM3303XX1000	MXRM3303XX1000
	2,650-5,299	MXCM3303XX2650	MXDM3303XX2650	MXPM3303XX2650	MXRM3303XX2650
	5,300-6,500	MXCM3303XX5300	MXDM3303XX5300	MXPM3303XX5300	MXRM3303XX5300
1" 2-Cell Product Standard color is Black (BK)	250	MXCM3302XX250	MXDM3302XX250	MXPM3302XX250	MXRM3302XX250
	500-999	MXCM3302XX500	MXDM3302XX500	MXPM3302XX500	MXRM3302XX500
	1,000-2,649	MXCM3302XX1000	MXDM3302XX1000	MXPM3302XX1000	MXRM3302XX1000
	2,650-5,299	MXCM3302XX2650	MXDM3302XX2650	MXPM3302XX2650	MXRM3302XX2650
	5,300-6,500	MXCM3302XX5300	MXDM3302XX5300	MXPM3302XX5300	MXRM3302XX5300
1" 1-Cell Product Standard color is Black (BK)	250	MXCM3301XX250	MXDM3301XX250	MXPM3301XX250	MXRM3301XX250
	500-999	MXCM3301XX500	MXDM3301XX500	MXPM3301XX500	MXRM3301XX500
	1,000-2,649	MXCM3301XX1000	MXDM3301XX1000	MXPM3301XX1000	MXRM3301XX1000
	2,650-5,299	MXCM3301XX2650	MXDM3301XX2650	MXPM3301XX2650	MXRM3301XX2650
	5,300-6,500	MXCM3301XX5300	MXDM3301XX5300	MXPM3301XX5300	MXRM3301XX5300

## 1" MAXCELL REEL SIZES AND WEIGHTS

DESCRIPTION	STD. PRODUCT LENGTH	REEL SIZE	TYPE OF REEL	TARE WEIGHT OF REEL	REEL WT. W/ STD. PRODUCT LENGTH	MAX PRODUCT ON REEL
1" 3-Cell Standard/Plenum/Riser MXCM3303 Prod. Wt: 44 lbs/1,000ft	500'	33"H x 15"W	Composite	60 lbs	88 lbs	2,053'
	1,000'	33"H x 15"W	Composite	60 lbs	104 lbs	2,053'
	2,650'	33"H x 22"W	Composite	85 lbs	202 lbs	3,893'
	5,300'	48"H x 22"W	Steel	78 lbs	289 lbs	6,500'
1" 2-Cell Standard/Plenum/Riser MXCM3302 Prod. Wt: 30 lbs/1,000ft	500'	33"H x 15"W	Composite	60 lbs	75 lbs	2,995'
	1,000'	33"H x 15"W	Composite	60 lbs	90 lbs	2,995'
	2,650'	33"H x 22"W	Composite	85 lbs	165 lbs	5,678'
	5,300'	48"H x 22"W	Steel	78 lbs	214 lbs	6,500'
1" 1-Cell Standard/Plenum/Riser MXCM3301 Prod. Wt: 17 lbs/1,000ft	500'	33"H x 15"W	Composite	60 lbs	69 lbs	5,533'
	1,000'	33"H x 15"W	Composite	60 lbs	77 lbs	5,533'
	2,650'	33"H x 15"W	Composite	60 lbs	106 lbs	5,533'
	5,300'	33"H x 22"W	Composite	78 lbs	176 lbs	6,500'

Add 8.5 lbs per 1,000ft for Detectable product weight estimates.



# PART NUMBER OVERVIEW

All MaxCell is white in color. The heavy thread “stripe” running along the length of the MaxCell “pack” is specified by the part numbers below. Each individual pull tape in each cell has its own unique thread “stripe” for easy identification. Pull tapes are either white, white with blue stripe, or white with orange stripe. MaxCell is offered in a variety of configurations and reel sizes. The part numbers used for ordering MaxCell are constructed using as many as 14 characters.

## MXC3456XX10000

**MX** is the standard prefix to identify the product as a MaxCell product.

**C** is the Product Line Code (C-Standard, D-Detectable, P-Plenum, R-Riser, CM-1")

**3456** is the Product Configuration Code (3456-3" 3-Cell, 2002-2" 2-Cell, 2003-2" 3-Cell, 4003-4" 3-Cell, 2001-2" 1-Cell, 330X-1")

**XX** is the Color Code (BK-Black, RD-Red, BL-Blue, YL-Yellow, WH-White, GR-Green)

**10000** is a Standard Footage\* (Standard Footages used in Part Number)

*\*The Standard Footages used in our part numbers do represent standard put-up reel lengths. Standard Footages are also used for custom orders, but such orders require textual definition to specific reel lengths.*

### STANDARD COLORS

- 3" 3-Cell: Black, Blue, Red
- 2" 2-Cell: Black
- 2" 3-Cell: Yellow
- 2" 1-Cell: White
- 4" 3-Cell: Green
- 1": Black



# 300 MILLION FEET OF MAXCELL INSTALLED GLOBALLY

# 80% SAVINGS SHIPPING COST

vs. HDPE

A graphic comparing shipping costs. It features ten truck icons arranged in two rows of five. The top row consists of five black truck icons, representing HDPE. The bottom row consists of five blue truck icons, representing MaxCell. The blue trucks are smaller than the black trucks, visually representing the 80% savings in shipping cost.

# INSTALLATION INSTRUCTIONS

## TWO REQUIREMENTS ARE VERY IMPORTANT:

- Swivels must always be used. (Please consult MaxCell representative for complete swivel options.)
- The factory installed 1,250lb pull tapes must free-float during installation.

## INSTALLATION INSTRUCTIONS | SINGLE PACKS

- 1 Make a 2" incision through the MaxCell, 18" from the end. This incision should be parallel to the product and made 1/2" from the colored stitch edge of the product.
- 2 Pull out all pull tapes through this incision and cut off excess. Push remaining ends of pull tapes back into the cells. The tapes must be pushed back far enough into the cells so that they free-float during installation.
- 3 Tie a 6-foot piece of pull tape or rope through incision. Secure with nonslip knot.
- 4 With the tied-on pull tape or rope, create three to four half-hitch knots down to the end of the MaxCell. The longer the pull, the more half-hitch knots are recommended. Under tension, tighten the half-hitch knots in succession, beginning with the closest to the incision. Apply black vinyl tape over last two half-hitch knots and to the end of MaxCell.
- 5 Tie the end of the exposed pull tape to a swivel using a nonslip knot. Tie the end of the pull tape or rope from the conduit to the other end of the swivel.
- 6 Begin pulling MaxCell into the conduit. To further ensure the MaxCell does not spiral during installation, hand guide the MaxCell into the conduit opening and maintain the angle and face of the MaxCell pack throughout installation.

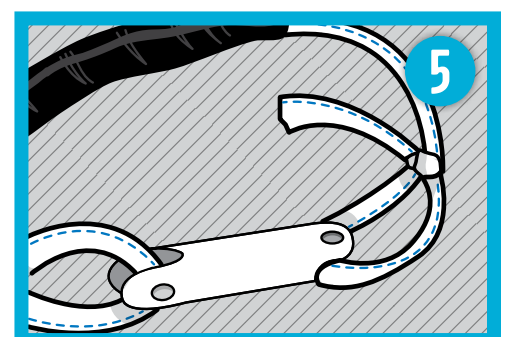
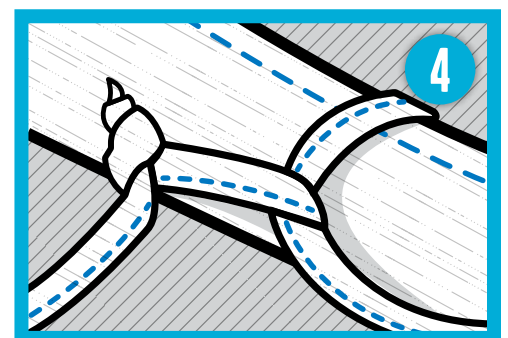
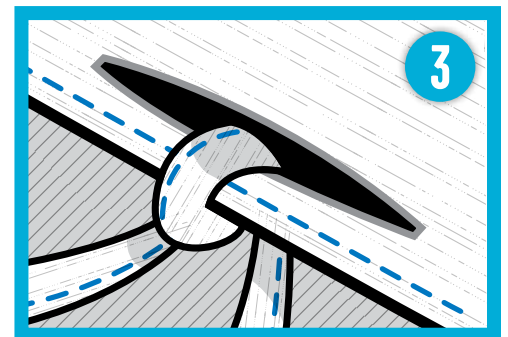
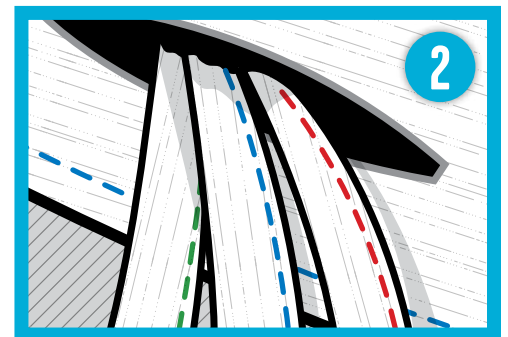
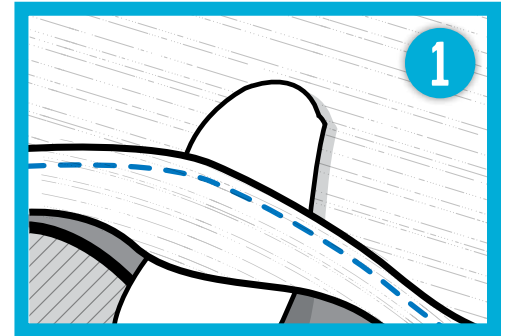

## INSTALLATION INSTRUCTIONS | MULTIPLE PACKS

- 7 Repeat steps 1 through 4 above for each individual MaxCell "pack" being installed.
- 8 Tie a 6-foot piece of pull tape or rope to all MaxCell sleeves, and create your three to four half-hitch knots around all the sleeves at one time. All tapes should be free-floating. *Note: It is recommended that the center MaxCell sleeve in a 3-way pull be aligned 1/2 turn coming off the reel so that the color stitching is opposite the top 1/2 bottom sleeve.*
- 9 Begin pulling the MaxCell packs in. For best results, hand feed the packs into the conduit, keeping them together and faced the same way through the entire pull.



SCAN QR CODE | WATCH INSTALLATION VIDEO



MaxCell field professionals have over twenty years of experience installing cable in the network construction industry. Since 1999, we have developed proven installation techniques specifically designed for MaxCell. The installation kits below are cost-effective, reusable and tested to be the most efficient means for MaxCell installations.

## **MXCIK11** *(Pictured Above)*

This kit is a single 2,500 lb swivel with an outside diameter of .875" and is designed for use in installing single and multiple packs of our MaxCell product.

## **MXCIK21** *(Pictured Below)*

This kit contains (3) 2,500 lb swivels with an outside diameter of .875" each and (1) 2-way chain harness. Designed for installing single or multiple packs of MaxCell attached to (1) swivel and a rope, tape or cable attached to a second swivel. The 3rd swivel acts as a parent swivel that attaches the main pull line to the chain harness. This kit allows for different products to be placed simultaneously with the MaxCell product while helping to reduce the number of twists in the conduit structure.

## **MXCIK31CH**

This kit contains (4) 2,500lb swivels with an outside diameter of .875" each and (1) 3-way chain harness. Designed for installing single or multiple packs of MaxCell attached to (1) swivel while the 2nd or 3rd swivel can be attached to either a rope, tape and/or cable. The 4th swivel acts as a parent swivel that attaches the main pull line to the chain harness. This kit allows for the installation of a rope or two cables to be placed simultaneously with the MaxCell product while helping to reduce the number of twists in the conduit structure. In addition, MaxLube pulling lubricant is recommended for all installations to further reduce pulling tensions.



**INSTALL**  
**2X**  
**FASTER**



Utilization of proper cable-pulling lubricants is essential in obtaining optimum results. MaxLube was specifically designed to improve MaxCell's performance under the most challenging applications. MaxCell used with MaxLube provides the fastest pull possible, reducing installation times significantly.

- Lubricates with a very thin film, performs just as well after drying
- Compatible with common cable jackets including polyethylene
- Easy application with pre-saturated wipe, re-saturate wipe with spray bottle as needed
- Perfect for OSP, drop and data cables
- Non-staining, quick cleanup

*MaxLube is a convenient lubricant for pulling fiber optic cables with wipe-and-spray application. Because it's concentrated, only a thin film is required for immediate tension reduction that lasts. Just spray or wipe the cable as it enters the MaxCell sleeve. It's quick and easy to use, without mess or excess lubricant.*



## SELF-INFLATING SEALING BAG



MaxBag is designed to create a seal between the underground cable conduit and the cable(s) for telecommunications or other uses. It's fast and easy to install. Simply pull the cord and it automatically inflates. MaxBag configurations support 2-, 3- and 4-inch conduit applications.

### FEATURES

MaxBag is activated manually with no tooling requirement. Inflation is achieved via a pull cord mechanism activating an internal gas capsule as opposed to using external compressed air. This provides the following advantages:

- Consistent inflation
- No tools required
- No maintenance required for inflation tools and accessories
- Fast, flexible and easy to install, reducing installation time
- It is possible to install and seal even with water in the interior of the conduit
- Easy to remove
- Adaptable to any cable diameter (within nominal min. and max. cable OD)
- The life cycle of the product is a minimum of 20 years

## APPLICATIONS

MaxBag is designed to create a barrier against the infiltration of silt, dirt/mud, debris and rodents into or out of buried conduit while also facilitating cable organization. MaxBag internal pressure is near 43.5psi.

PART NUMBER	OUTER DUCT NOMINAL DIAMETER (APPROX.)	CABLE MAX DIAMETER (APPROX.)	CABLE MIN DIAMETER (APPROX.)
MXCB2	63 mm (2.48 in)	45 mm (1.77 in)	7 mm (0.27 in)
MXCB3	90 mm (3.54 in)	60 mm (2.36 in)	10 mm (0.39 in)
MXCB4	110 mm (4.33 in)	80 mm (3.14 in)	12 mm (0.47 in)

## TESTS

NAME	METHOD
Sealing	Immersion in water for 48 hours with a pressure of 50kPa (7.252psi)
Thermal Cycle	20 cycles of 12 hours oscillating between 15° and 50° C (59° to 122° F)
Vibration	10 day cycle with 10Hz vibration in the test cable
Chemical	Acid, hydroxide, sulfide, chloride and petrol by product resistance
Working Temp	-50° to 70° C (-58° to 158° F)



# REUSABLE TERMINATION BAGS

MaxCell conforms to the shape of cables placed within and greatly reduces the wasted space associated with rigid innerduct. When you use MaxCell with a reusable termination bag, you'll save time and money every time you deploy cable.

Reusable termination bags can provide an airtight seal in innerduct diameters ranging from 2 inches to 5 inches. The patented inflatable ADE/V sealing elements are made of a laminated foil developed for aircraft application. The sealing element is placed in the duct around cables and inflated to the required air pressure via a durable metal tire valve, completely sealing the innerduct. The sealing element may be easily removed by releasing the air pressure, again via the tire valve. This allows incremental cable deployments and reduces your total installation cost.

- Extremely low leakage rate of 2.7 mbarl/year
- Service life of 20 years against gas diffusion
- Up to 16 feet water column (7 psi)
- Chemicals from pH2 to pH12



PART NO.	DESCRIPTION	INNERDUCT DIAMETER (INCH)	DUCT SEALING RANGE OCCUPANCY OPTIMAL DIAMETER (INCH)	DUCT SEALING RANGE OCCUPANCY MINIMAL DIAMETER (INCH)
MXCRTBVL50	Sealing element for temperature range +5°F to +86°F Duct 0 ~ 2 inch	2	1.3	0
MXCRTBVL80	Sealing element for temperature range +5°F to +86°F Duct 0 ~ 3 inch	3	2.2	0
MXCRTBVL100	Sealing element for temperature range +5°F to +86°F Duct 0 ~ 4 inch	4	2.9	0
MXCRTBVL125	Sealing element for temperature range +5°F to +86°F Duct 0 ~ 5 inch	5	3.5	0.7



# VERRIDE PADDLES



A MaxCell Rodder Head or “paddle” is the most effective tool for overriding existing cable plant. Insertion of the paddle over the top of existing cables presses the cables down in the conduit, creating a larger open space at the top for the placement of MaxCell and subsequent additional cable. The correct size of the Rodder Head selected for any application depends on several factors, including:

- **Inside diameter of the conduit**
- **Distance the rod is to be pushed**
- **Number and radiuses of bends in the conduit run**
- **Overall physical condition or continuity of the conduit run**
- **Existing fill ratio of the incumbent plant**

Use of a MaxCell Rodder Head can facilitate placement of MaxCell innerduct. Once the Rodder Head exits the conduit run, MaxCell can be affixed to the paddle with a proper swivel in between. MaxCell can be placed in the conduit as the Rodder Head is extracted to the insertion point. A pull rope or jacketed polyester rope can also be placed during Rodder extraction, allowing for future placement of MaxCell.

## PADDLE WIDTH 1-3/4"

PBC3/8200, Clevis, Pull Back, 3/8-16  
Female Threaded, for 2" duct

## PADDLE WIDTH 2-7/8"

PBC3/8300, Clevis, Pull Back, 3/8-16  
Female Threaded, for 3" duct

## PADDLE WIDTH 3-7/8"

PBC3/8400, Clevis, Pull Back, 3/8-16  
Female Threaded, for 4" duct



# PLACING IN OCCUPIED CONDUIT

We have determined that it is poor practice to pull a cable directly into an existing plant due to the associated risk of damaging the existing cable sheath and ultimately the viability of the network. With this in mind, MaxCell has developed construction practices for installing MaxCell in occupied conduits.



**1** First, it is preferred that the conduit be less than 30% occupied by volume, or less than 50% full if you were to draw a line horizontally across the halfway point of the conduit opening.

- **2" conduit can hold up to three 0.70" cables**

- **4" conduit can hold up to nine 0.80" cables**

The condition of the occupied conduit should be determined. It is unlikely that MaxCell will be effective in very poor duct structures.

**2** A MaxCell Rodder Head (or paddle) is the most effective tool for overriding existing cable plant. The size of MaxCell Rodder Head required is dependent upon the conduit diameter. The MaxCell Group can help you select the right size head for your duct structure. The head selected is matched to the inside diameter of the conduit.

**3** The MaxCell Rodder Head is attached to the threaded end of a fiberglass or steel rod. The head is fed into the duct ON TOP of the existing cables. If the head is not on top of the cables to start, there is the likelihood that the cables can get tangled. The head actually pushes the cables to the bottom half of the structure, allowing the rodder to proceed without becoming entangled with the existing cables.

**Which is the right rod for any given application? The rod selection is usually governed by several factors including:**

- **Size of ducting it is to be pushed through**
- **Distance the rod is to be pushed**
- **Number and tightness of bends in the duct**

A smaller rod in a large duct will make more frequent contact with the conduit; the same rod in a smaller duct will make less-frequent contact and therefore less friction so it can be pushed further. A large rod in a small duct is a good situation, but reduced flexibility of the rod may cause increased friction in the tighter bends.

**4** After the rodder is successfully placed, there are two options:

**a.** The MaxCell pack can be pulled back over the cables with the rodder. The fiberglass rodder is less likely to cause damage to the existing cable sheath than an abrasive pull tape or rope.

**b.** A rope can be pulled into the conduit by attaching it to the installed rodder with the MaxCell placed at a later time. If this method is chosen, we recommend that MaxGlide (a jacketed polyester rope) be used. MaxGlide is made out of the same material as the cable sheath and is less likely to cause sheath damage to the existing cable. We also suggest lubricating the MaxGlide with a silicone cable lubricant to further reduce friction between the rope and cable.

**5** When placing the MaxCell with rodder or rope, use the standard MaxCell installation procedure for attaching to the MaxCell — and always use a swivel to prevent twisting. Depending on the application, overriding existing cables can present its challenges, but it can save valuable construction dollars.

**Some factors that may limit overriding include:**

- **Conduit size**
- **Conduit fill**
- **Distance of run**

# INCREASE SPACE, INCREASE CAPACITY.

From the engineers that brought you MaxCell comes the next technology that can add up to nine additional cables in a conduit filled with rigid innerduct and cables.

Since 1999, MaxCell has enabled network construction managers of green field projects to install a greater number of cables in less conduits than ever possible with rigid innerduct. In many applications through the years, MaxCell has been installed in partially occupied ducts to override existing cables and avoid the need for new conduits and expensive trenching costs. But in conduit structures “filled” with rigid innerduct, little space is available for MaxCell and additional cable installation. With today’s network expansion projects, service providers are often forced to endure the high costs of new trenches and conduit to provide needed services.

*MaxSpace can greatly reduce expensive infrastructure projects.*

**MaxSpace**<sup>®</sup>  
CONDUIT SPACE  
RECOVERY  
Conduit Maximization Solutions



## DON'T DIG — RECLAIM!

MaxSpace<sup>®</sup> is a NO DIG conduit space recovery solution designed to safely remove rigid innerduct from existing conduit without endangering active cables. Imagine what you can save in a conduit that was “full” with just three cables — now having space for up to nine new cables.

## THE MAXSPACE SERVICE

- Recover space by removing rigid innerduct as cable is operating
- Active cables protected in a split metal tube (cables see little to no load)
- Extract innerduct that consumes most of the conduit space
- Incumbent cables settle to the bottom of conduit
- MaxCell is placed as rigid innerduct is extracted
- Split and chip the rigid innerduct for easy recycling and disposal
- Install new cables when needed

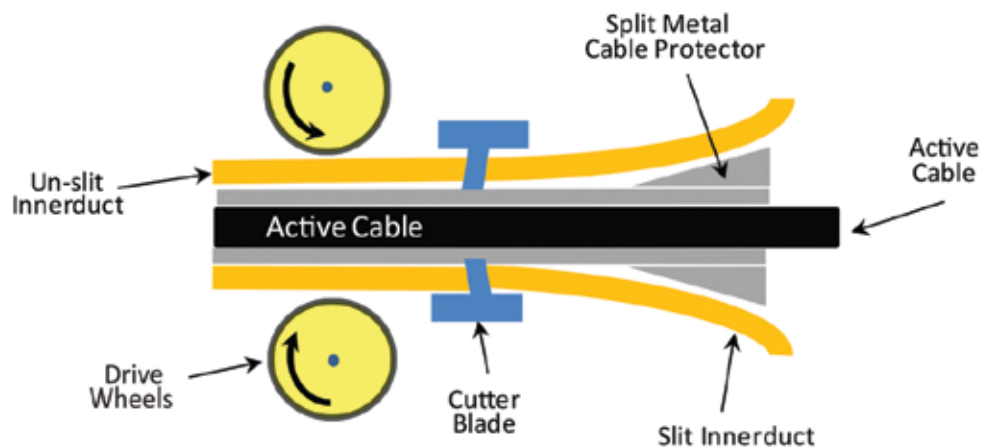

## THE MAXSPACE SOLUTION

The Conduit Space Recovery Unit uses a split metal sleeve to protect the active cable while the innerduct is extracted. Rigid innerduct is then drawn into the machine using opposing drive wheels that force the innerduct through four cutting blades, slicing the innerduct into quarters. The sliced innerduct is then fed into a chipping machine and compressed into disposal bags.

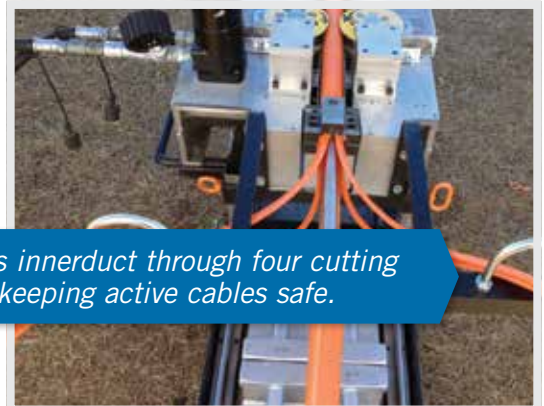

*The Conduit Space Recovery Unit feeds innerduct through four cutting blades, removing rigid innerduct while keeping active cables safe.*

# FEATURES & BENEFITS

*The MaxSpace solution and installation team exceeded my expectations and I want to say thanks for the effort and bringing the new solution to UCF.*

*Jason Musick, Installation Maintenance and Repair Supervisor (IMR) | University of Central Florida*

## NETWORK

- Recover up to 90% of conduit space
- Add up to 9 new cables
- No Disruption of service
- Cables can be placed immediately
- Safer than trenching or boring around current infrastructure
- Service customer needs faster
- Larger diameter cable can be placed in MaxCell

## BUDGET

- Save significant costs
- A NO DIG Solution
- NO engineering costs
- NO new trenches
- NO new conduit
- NO trenching permits required
- NO EPA oversight
- NO Right-of-Way red tape
- NO property restoration costs from trenching or boring

## CONSTRUCTION

- Fast Process — A NO DIG Solution
- Remove innerduct in a fraction of time of trenching or boring
- Compact machine for tight vault spaces
- Less than 50 lbs. of tension on cables
- Install MaxCell during same service
- Easy disposal & recycling of rigid innerduct
- Homeowners and businesses are not inconvenienced
- Safer for pedestrian traffic

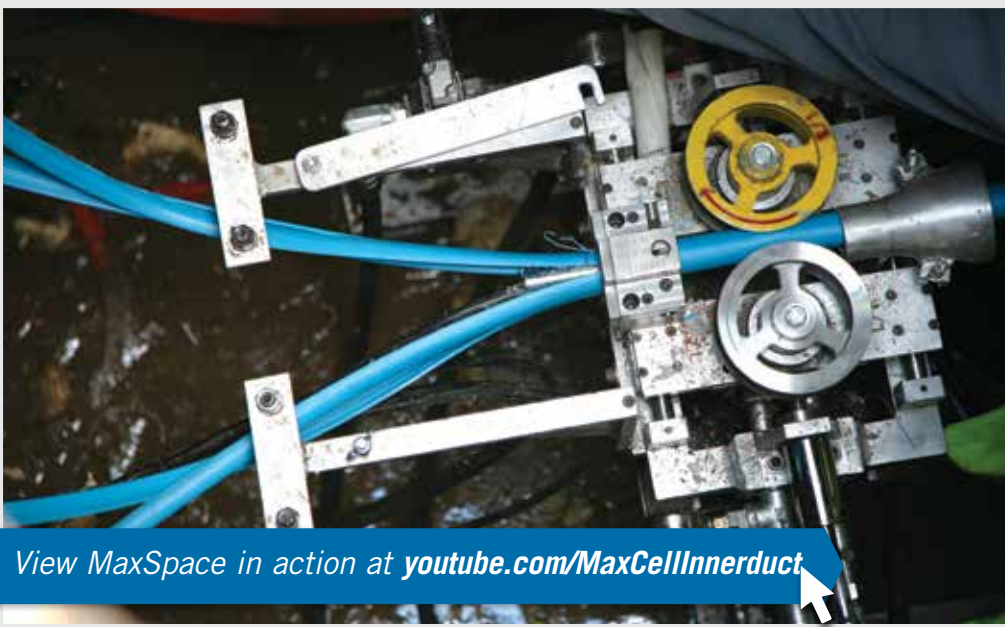

View MaxSpace in action at [youtube.com/MaxCellInnerduct](https://youtube.com/MaxCellInnerduct)

## MAXCELL TO MAXIMIZE YOUR RECLAIMED SPACE!

Complete your MaxSpace project by filling your new available space with MaxCell! Over 300 million feet of MaxCell — equaling nearly 600 million feet of cable channel — have been installed globally. With its flexibility and space compression features, you can install up to 300% more cables in your network structures with MaxCell. Available in Standard, Detectable, Plenum, Riser and Self-Supporting, as well as in various sizes and numbers of cells, MaxCell can be used in any conduit encased, in cabletray, or wall-mounted network infrastructure. Use that new space to load your pathways with MaxCell and provide room for cables you need now and in the future!



REMOVE



RECOVER



RENEW

# THE WORLD'S MOST FLEXIBLE, MOST SUSTAINABLE INNERDUCT.

## MORE SPACE. MORE PRODUCTIVITY. MORE GREEN.

As consumer awareness and concern about climate change and the environment grow, companies are taking steps to reduce their carbon footprint and demonstrate their commitment to sound environmental stewardship. Designed specifically for the network construction industry, MaxCell is a flexible fabric innerduct that provides cable pathway functionality at a fraction of the cost, labor, energy, space and carbon emissions versus HDPE innerduct.

## A PATHWAY TO SUSTAINABILITY.

For every million feet of single-cell MaxCell installed instead of HDPE innerduct, the resulting carbon savings are 644 metric tons CO<sub>2</sub> equivalent. These Green House Gas (GHG) savings are equal to the annual GHG emissions from over 126 passenger vehicles on the road or over 72,000 gallons of gasoline consumed. Over 300 million feet of MaxCell innerduct have been successfully installed around the globe. If you want to increase your productivity, improve your bottom line and reduce your carbon footprint, MaxCell is the solution.

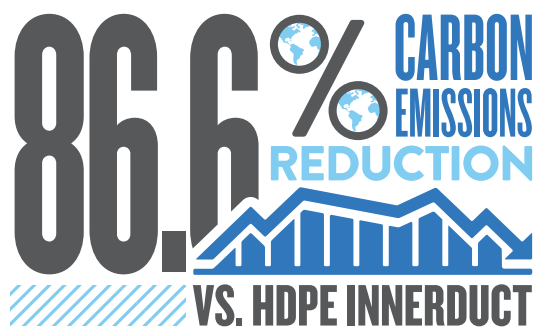

MaxCell worked with ICF International, which for 25 years has provided world-class support for the modeling and simulation of environmental impacts of public and private clients, to develop a comprehensive product carbon footprint to determine carbon emissions. ICF International found that across its product life cycle, MaxCell's carbon footprint is 86.6% less than HDPE innerduct (660 kg CO<sub>2</sub> equivalent per 1,000 feet of single cable pathway).

## CARBON FOOTPRINT COMPARISON (KG CO<sub>2</sub> EQUIVALENT PER SINGLE CABLE PATHWAY)

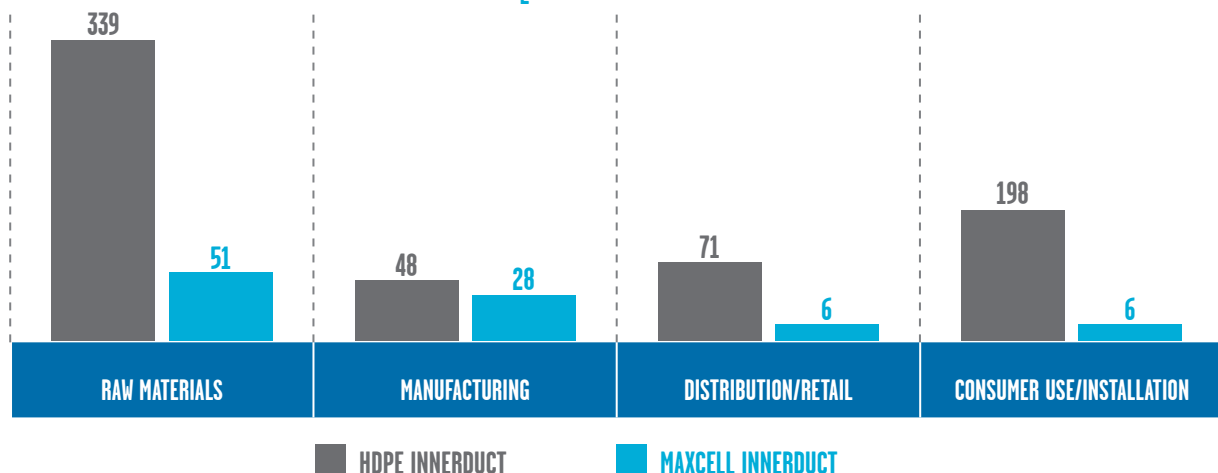



IF YOU WANT TO  
**INCREASE**  
YOUR **PRODUCTIVITY** AND  
**BOOST** YOUR  
BOTTOM LINE

MAXCELL IS THE SOLUTION

